

Specifications

For other materials or modifications, please consult TESCOM.

OPERATING PARAMETERS

Pressure rating per criteria of ANSI/ASME B31.3

<p>Maximum Inlet Pressure Brass: 6000 psig / 413 bar Stainless Steel: 10,000 psig / 690 bar Stainless Steel (Spring and Air Load only): 15,000 psig / 1034 bar</p> <p>Outlet Pressure Ranges See Part Number Selector</p> <p>Design Proof Pressure 150% of rated pressure</p> <p>Leakage Non-Metal Seat: Bubble-tight Metal Seat: 2 drops/minute at 150 SUS at 2500 psig / 172 bar</p> <p>Operating Temperature -15°F to 165°F / -26°C to 73°C</p> <p>Flow Capacity $C_v = 0.02, 0.06, 0.12, \text{ or } 0.30$</p>

MEDIA CONTACT MATERIALS

<p>Body 316 Stainless Steel or Brass</p> <p>Seat, Vent, and Main Valve See Part Number Selector</p> <p>O-Ring See Part Number Selector</p> <p>Back-up Ring PTFE</p> <p>Filter* 26-201XX-XX: Bronze 26-202XX-XX: 300 Series Stainless Steel</p> <p>Remaining Parts 316 Stainless Steel and 17-4 PH Stainless Steel</p>
--

OTHER

<p>Cleaning CGA 4.1 and ASTM G93</p> <p>Weight (approximate) 5.5 lbs / 2.5 kg</p>

*no filter with metal seat

Teflon® is a registered trademark of E.I. du Pont de Nemours and Company.



TESCOM 26-2000 Series high pressure, low flow piston sensed regulator is available in dome, spring and air load versions. This regulator comes with segregated captured venting standard with inlet pressure ratings of 6000-15,000 psig / 413-1034 bar.

Applications

- R&D labs
- Pressure filling
- Calibration testing
- Burst testers
- Component testing
- High pressure hydraulic or pneumatic applications

Features and Benefits

- Segregated captured vent is standard
- Three standard loading methods - spring, dome, and air actuated
- Available with soft and metal-to-metal seating
- Standard 40 micron internal filter (soft seated models) increases service life
- High flow version is available with C_v of 0.30
- An excellent choice to be used with the TESCOM ER5000 Electropneumatic Controller

26-2000 SERIES

26-2000 Series Regulator Drawings

SPRING LOADED

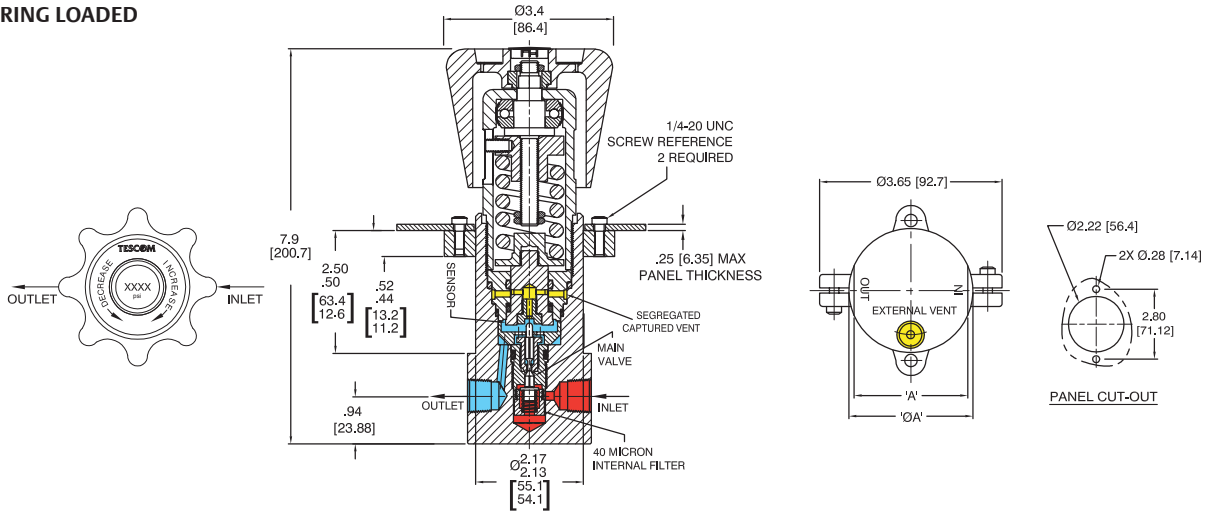

DOME LOADED

INLET & OUTLET PORT	'A'
ALL 1/4 EXCEPT NPTF	2.30
1/4 NPTF	Ø2.48
3/8 NPTF	Ø2.48
ALL 3/8 EXCEPT NPTF	2.90
1/2 MS33649	2.90
1/2 NPTF	Ø3.20

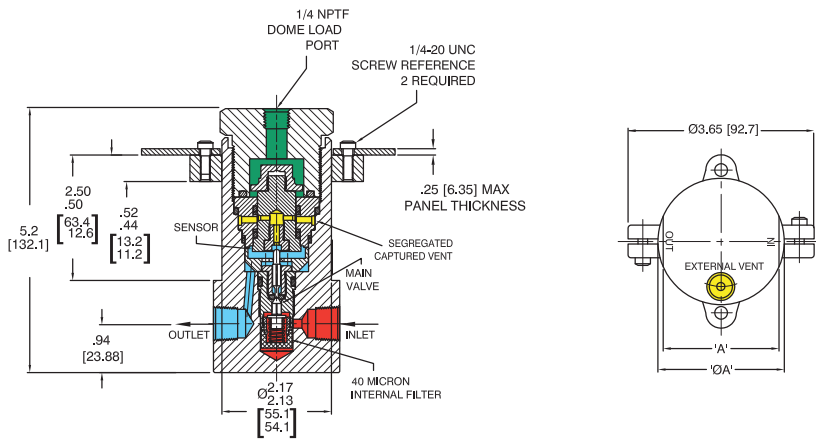

AIR LOADED

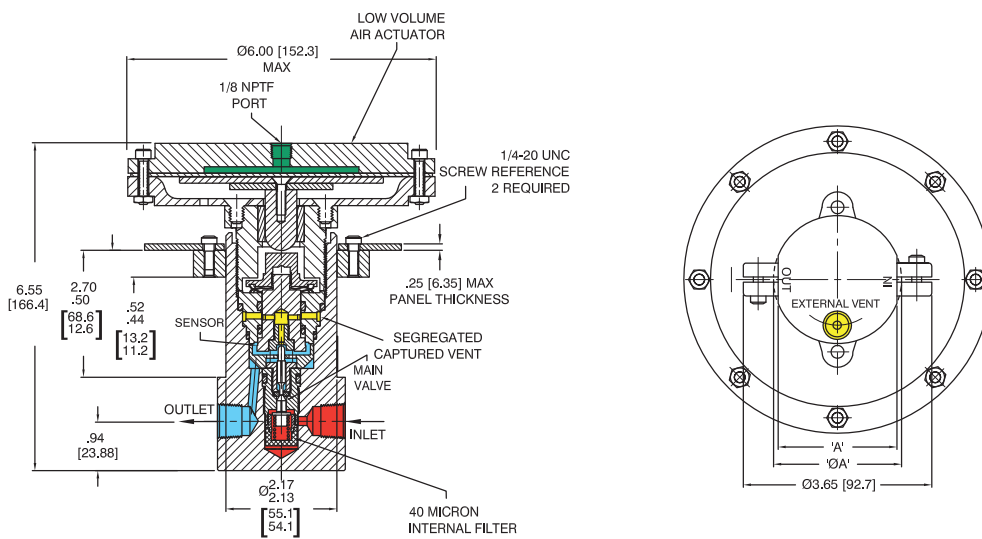

All dimensions are reference & nominal
Metric [millimeter] equivalents are in brackets

26-2000 Series Regulator Flow Charts

For more information on how to read flow curves, please refer to the Flow Curves and Calculations document (debul2007x012) in the TESCO catalog or on www.tescom.com.

SPRING LOADED

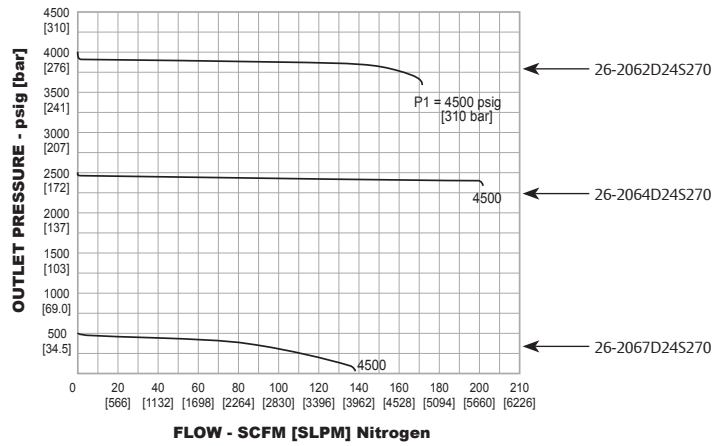

DOME LOADED

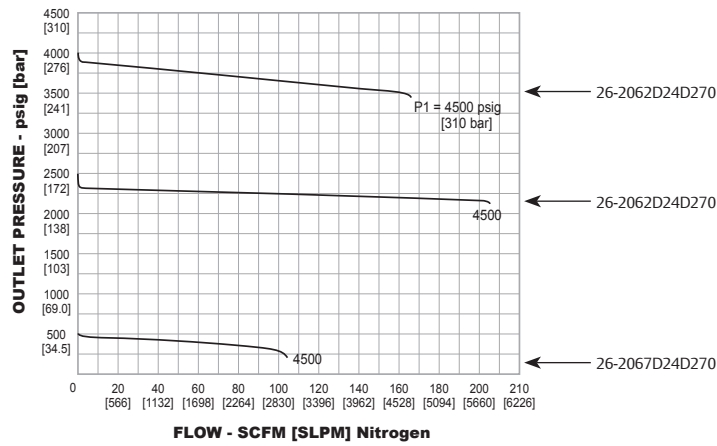

AIR LOADED

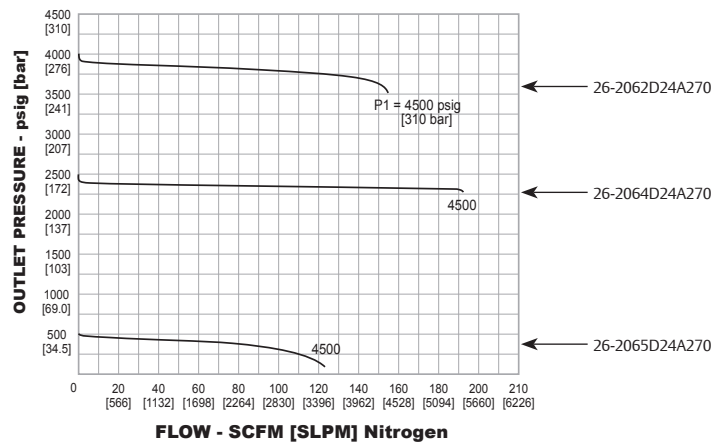

26-2000 SERIES

26-2000 Series Regulator Part Number Selector

i Learn more about common options.

For modifications, repair kits and accessories, contact factory.

Example for selecting a part number:

26-20 6 1 A 2 4 5 1 7 0

S – Spring load
D – Dome load
A – Air load

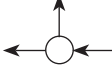
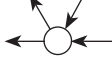
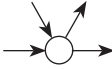
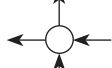
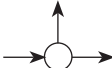
BASIC SERIES	BODY MATERIAL	MAXIMUM INLET PRESSURE	OUTLET PRESSURE	SOFT GOODS MATERIAL		INLET AND OUTLET PORT TYPE	VENT PORT	INLET AND OUTLET PORT SIZE	FLOW CAPACITY (C _v)	MAIN VALVE AND VENT SEAT MATERIAL	GAUGE PORT OPTIONS 1/4" NPTF												
				O-RING	BACKUP RING																		
26-20	1 – Brass 6 – 316 Stainless Steel 9 – 316 Stainless Steel <i>(spring and air load only)</i>	6000 psig 413 bar 10,000 psig 690 bar 15,000 psig ¹ 1034 bar	Spring Load 1 – 200-10,000 psig 14-690 bar <i>(Stainless steel body only)</i> 2 – 50-6000 psig 3.4-413 bar 3 – 25-4000 psig 1.7-275 bar 4 – 15-2500 psig 1-172 bar 5 – 10-1500 psig 0.7-103 bar 6 – 5-800 psig 0.35-55 bar 7 – 5-500 psig 0.35-35 bar Dome Load 1 – 200-10,000 psig 14-690 bar <i>(Stainless Steel body only)</i> 2 – 50-6000 psig 3.4-413 bar 7 – 5-500 psig 0.35-35 bar Air Load 1 – 200-10,000 psig 14-690 bar <i>(Stainless Steel body only)</i> 2 – 50-6000 psig 3.4-413 bar 4 – 15-2500 psig 1-172 bar 5 – 10-1500 psig 0.7-103 bar	A – PTFE B – Nitrile, Buna-N (90 durometer) D – Nitrile, Buna-N (70 durometer) T – FKM (Viton®-A) U – Urethane V – FFKM, Perfluoroelastomer (Kalrez®) Z – E.P	PTFE PTFE PTFE PTFE PTFE PTFE	1 – SAE 2 – NPTF 3 – MS33649 4 – High pressure/ Aminico 6 – Medium pressure/ Slimline	1/4" SAE 1/4" NPTF 1/4" MS33649 1/4" NPTF 1/4" NPTF	4 – 1/4" 6 – 3/8" 8 – 1/2" ²	1 – .02 <i>(not available for metal seated models)</i> 2 – 0.06 3 – 0.12 ³ <i>(metal and/or Polyimide (Vespel®) seat only)</i>	5 – 17-4 Stainless Steel 7 – Polyimide (Vespel®) 8 – Peek	0 – None  1 – One Outlet Gauge at 90°  2 – Two Gauge Ports at 60°  3 – Two Gauge Ports at 60° (left hand inlet)  4 – Two Gauge Ports at 90°  5 – One Outlet Ports at 90° (left hand inlet) 												
												<p>1. 15,000 psig / 1034 bar inlet requires a CTFE back-up ring on main valve. 2. 1/2" not available in High (Aminico) or Medium (Slimline) pressure ports. 3. Not available with 15,000 psig / 1034 bar inlet.</p>											